

Professional in HVAC/R Tools



VALUE Mechanical & Electrical Products CO., LTD

Add: Jiulong Avenue, Western Industrial District, Wenling, Zhejiang, China

Tel: +86-576-86191959

Fax: +86-576-86191957

Email: value@worldvalue.cn

[Http://www.worldvalue.cn](http://www.worldvalue.cn)

2015 - 2016
www.worldvalue.cn

VALUE[®]



WELCOME TO VALUE

PROFILE

VALUE company is professionally dedicated to the research and manufacture of refrigeration tools and equipments nearly 20 years, which has a location area of 26600m² and building area of 41800m². With the three core competitiveness of continuous technique innovation capability, social resources integrating capability and worldwide distribution network, VALUE is at the leading position in refrigeration industry globally since.



We focus on research, making the impossible possible.
We continue innovating, not conceited with current achievements.
VALUE insists on the innovative spirit and rigorous attitude all the time.
We commit to providing products and service with high quality and high performance-price ratio, to create value and meet your requirements.

HONOR & CAPABILITY

VALUE is honored as National High Tech-Science Corporation, Member of National Vacuum Technique Standardization Technical Committee, China Porch Program Corporation, National Sci-Innovative Enterprise, UN Environment Programme Equipment-Bidder Enterprise, China Aviation Industry Supporting Corporation.....

With the annual production capacity of 500,000 pieces, VALUE achieved the turnover of 250 million RMB in 2014, with 130 million from abroad markets. And we paid duty of 18 million RMB in 2014.



INNOVATION

VALUE commits continuous investments to R&D, to develop better products. We invest 15 million in research every year, and have got over 100 patents in China.

VALUE possesses a large number of talents, with 35% of whom are high-educated experts. With over 40 senior experts in motor, electric, vacuum technology and industrial designing, we are capable of offering personalized design and service for you in the shortest time.

QUALITY

Our products are qualified with world's most advanced quality level. We have European CE, American UL, Canada CSA safety certificates and German TUV ISO9001 certificate. And we also own product failure analysis lab, homo-thermal and homo-humid workshop, product model experiment center.

VALUE is fully equipped with modernized processing and testing instruments, such as Japan DMG Mori Seiki horizontal machining center, Japan OKUMA-BYJC vertical machining center, German WENZEL three coordinates measuring equipment, etc. We carry out ERP data management and precise manufacture mcde.

GLOBAL DISTRIBUTION

VALUE has sound sales network which covers more than 90 countries and regions, such as US, Japan, France, Italy, Spain, German, North Europe, Korea, Taiwan, Brazil, etc.

VALUE has also built our own brand distribution network in over 80 countries. VALUE provides products and service for 10 Fortune 500 enterprises as well.



Contents



VACUUM PUMP

VE N Series	3
New Refrigerant Series	5
R32 Refrigerant Series	7
Vacuum Gauge	8
Industrial Series	13



RECOVERY UNIT

M Series	18
L Series	19



REFRIGERANT TOOLS

Manifold Gauge	25
Single Gauge	30
Pressure Gauge	31
Digital Manifold Gauge	34
Accessory	36
> Refrigerant Tube	
> Quick Couplers	
> Check Valve	
> Adapter	
Leak Detector	38
Scale	39



PIPE TOOLS / HVAC INSTRUMENT

Flaring Tool	45
Bending Tool	50
Tube Expander	51
Tube Cutter	52
Deburring Tool	53
Tool Kit	54
HVAC Instrument	56
> Modern Digital Multimeter	
> Digital Clamp Multimeter	
> Infrared Thermometer	



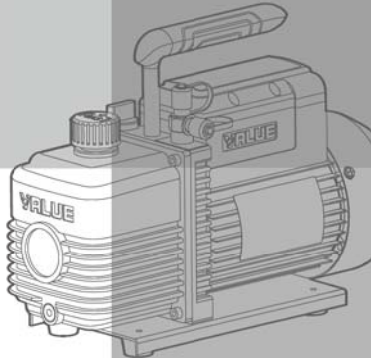

Vacuum Pump

High
Reliable

VE N SERIES

More Reliable, Higher Ultimate Vacuum



Forced oil cycling system



Integrated body structure



Big sight glass for monitoring oil level



Single Stage

Model	VE115N	VE125N	VE135N	VE160N	VE180N	
Flow Rate	50Hz	1.8 CFM	2.5 CFM	3.5 CFM	6.0 CFM	8.0 CFM
		51 L/min	70 L/min	100 L/min	170 L/min	226 L/min
Flow Rate	60Hz	2.0 CFM	3.0 CFM	4.0 CFM	7.0 CFM	9.0 CFM
		57 L/min	84 L/min	113 L/min	198 L/min	254 L/min
Ultimate Vacuum	Partial Pressure	2 Pa	2 Pa	2 Pa	2 Pa	2 Pa
	Total Pressure	150 micron	150 micron	150 micron	150 micron	150 micron
Power	1/4 HP	1/4 HP	1/3 HP	1/2 HP	3/4 HP	
Inlet Port	1/4" Flare	1/4" Flare	1/4"&3/8" Flare	1/4"&3/8" Flare	1/4"&3/8" Flare	
Oil Capacity	250 ml	250 ml	250 ml	415 ml	660 ml	
Dimensions	290x124x224 mm	290x124x224 mm	318x124x234 mm	338x138x244 mm	395x145x257 mm	
Weight	6.6 Kg	7.1 Kg	8.0 Kg	9.9 Kg	14.6 Kg	

Dual Stage

Model	VE215N	VE225N	VE245N	VE260N	VE280N	VE2100N	
Flow Rate	50Hz	1.5 CFM	2.5 CFM	4.5 CFM	6.0 CFM	8.0 CFM	10.0 CFM
		42 L/min	70 L/min	128 L/min	170 L/min	226 L/min	283 L/min
Flow Rate	60Hz	1.8 CFM	3.0 CFM	5.0 CFM	7.0 CFM	9.0 CFM	12.0 CFM
		50 L/min	84 L/min	142 L/min	198 L/min	254 L/min	340 L/min
Ultimate Vacuum	Partial Pressure	2x10 ¹ Pa	2x10 ¹ Pa	2x10 ¹ Pa	2x10 ¹ Pa	2x10 ¹ Pa	2x10 ¹ Pa
	Total Pressure	15 micron	15 micron	15 micron	15micron	15 micron	15 micron
Power	1/4 HP	1/3 HP	1/2 HP	3/4 HP	1 HP	1 HP	
Inlet Port	1/4" Flare	1/4" Flare	1/4"&3/8" Flare	1/4"&3/8" Flare	1/4"&3/8" Flare	1/4"&3/8" Flare	
Oil Capacity	200 ml	200 ml	325 ml	580 ml	500 ml	590 ml	
Dimensions	308x124x224 mm	318x124x234 mm	338x138x244 mm	395x145x257 mm	395x145x257 mm	395x145x257 mm	
Weight	7.5 Kg	8.5 Kg	10.4 Kg	15.8 Kg	16.2 Kg	16.7 Kg	

VE N SERIES

Dual Voltage (110-220V/50-60Hz)

Power plug

make this connection with different power plugs easily

Power supply conversion switch

make sure this switch is set on the right place before your operation: 110V or 220V



Dual Stage

Model	VE215ND	VE225ND	VE245ND	
Flow Rate	50Hz	1.5 CFM	2.5 CFM	4.5 CFM
		42 L/min	70 L/min	128 L/min
Flow Rate	60Hz	1.8 CFM	3.0 CFM	5.0 CFM
		50 L/min	84 L/min	142 L/min
Ultimate Vacuum	Partial Pressure	2x10 ¹ Pa	2x10 ¹ Pa	2x10 ¹ Pa
	Total Pressure	15 micron	15 micron	15 micron
Power	1/4 HP	1/3 HP	1/2 HP	
Inlet Port	1/4" Flare	1/4" Flare	1/4"&3/8" Flare	
Oil Capacity	200 ml	200 ml	325 ml	
Dimensions	318x124x234 mm	318x124x234 mm	338x138x244 mm	
Weight	8.5 Kg	8.5 Kg	10.4 Kg	

Model	VE260ND	VE280ND	VE2100ND	
Flow Rate	50Hz	6.0 CFM	8.0 CFM	10.0 CFM
		170 L/min	226 L/min	283 L/min
Flow Rate	60Hz	7.0 CFM	9.0 CFM	12.0 CFM
		198 L/min	254 L/min	340 L/min
Ultimate Vacuum	Partial Pressure	2x10 ¹ Pa	2x10 ¹ Pa	2x10 ¹ Pa
	Total Pressure	15micron	15 micron	15 micron
Power	3/4 HP	1 HP	1 HP	
Inlet Port	1/4"&3/8" Flare	1/4"&3/8" Flare	1/4"&3/8" Flare	
Oil Capacity	580 ml	500 ml	590 ml	
Dimensions	395x145x257 mm	395x145x257 mm	395x145x257 mm	
Weight	15.8 Kg	16.2 Kg	16.7 Kg	

NEW REFRIGERANT SERIES

Suitable for R410a, R407c, R1234a, R12, R22 refrigerant



High accuracy vacuum gauge shows system pressure



Automatic anti-backflow valve design



Integrated body structure



Big sight glass for monitoring oil level



Single Stage

Model	V-i120SV	V-i140SV	V-i160SV	V-i180SV
Flow Rate	50Hz	1.8 CFM 51 L/min	3.5 CFM 100 L/min	5.0 CFM 142 L/min
	60Hz	2.0 CFM 57 L/min	4.0 CFM 113 L/min	6.0 CFM 170 L/min
Ultimate Vacuum	Partial Pressure	2 Pa	2 Pa	2 Pa
	Total Pressure	150 micron	150 micron	150 micron
Power	1/4 HP	1/3 HP	1/2 HP	3/4 HP
Inlet Port	1/4" Flare	1/4" Flare	1/4" Flare	1/4" Flare
Oil Capacity	250 ml	250 ml	415 ml	660 ml
Dimensions	290x124x255 mm	318x124x265 mm	338x138x275 mm	395x145x318 mm
Weight	6.7 Kg	8.6 Kg	10.3 Kg	15.4 Kg

Dual Stage

Model	V-i220SV	V-i240SV	V-i260SV	V-i280SV
Flow Rate	50Hz	1.8 CFM 51 L/min	3.5 CFM 100 L/min	5.0 CFM 142 L/min
	60Hz	2.0 CFM 57 L/min	4.0 CFM 113 L/min	6.0 CFM 170 L/min
Ultimate Vacuum	Partial Pressure	2x10 ¹ Pa	2x10 ¹ Pa	2x10 ¹ Pa
	Total Pressure	15 micron	15 micron	15 micron
Power	1/3 HP	1/2 HP	3/4 HP	1 HP
Inlet Port	1/4" Flare	1/4" Flare	1/4" Flare	1/4" Flare
Oil Capacity	200 ml	325 ml	580 ml	500 ml
Dimensions	318x124x265 mm	338x138x275 mm	395x145x318 mm	395x145x318 mm
Weight	9.0 Kg	11.0 Kg	16.6 Kg	17.0 Kg

NEW REFRIGERANT SERIES

Suitable for R410a, R407c, R134a, R12, R22 refrigerant



Smaller, lighter, and more convenient
only 4kg



Specification

Model	V-i115S-M	V-i2115S-M
Flow Rate	1.5 CFM	1.5 CFM
Partial Pressure	2 Pa	2x10 ¹ Pa
Total Pressure	150 micron	15 micron
Power	1/5 HP	1/5 HP
Inlet Port	1/4" Flare	1/4" Flare
Oil Capacity	150 ml	110 ml
Dimensions	240x88x183 mm	240x88x183 mm
Weight	3.5 Kg	4 Kg

Both AC&DC can be operated



• Chinese patent



Specification

Model	V-i210H
Flow Rate	1.0 CFM
Partial Pressure	2x10 ¹ Pa
Total Pressure	15 micron
Power	1/5 HP
Inlet Port	1/4" Flare
Oil Capacity	150 ml
Dimensions	240x88x183 mm
Weight	4 Kg

R32 REFRIGERANT SERIES



Suit for R32, 1234yf refrigerant

Integrated body structure



Horizontal position easy for reading



Enclosed switch



• Chinese patent 

Dual Stage

Model	V-i240Y-R32	V-i260Y-R32	V-i280Y-R32	
Flow Rate	50Hz	3.5 CFM 100 L/min	5.0 CFM 142 L/min	7.0 CFM 198 L/min
	60Hz	4.0 CFM 113 L/min	6.0 CFM 170 L/min	8.0 CFM 226 L/min
Ultimate Vacuum	Partial Pressure	2x10 ⁻¹ Pa	2x10 ⁻¹ Pa	2x10 ⁻¹ Pa
	Total Pressure	15micron	15 micron	15 micron
Power	1/2 HP	3/4 HP	1 HP	
Inlet Port	1/4" Flare	1/4" Flare	1/4" Flare	
Oil Capacity	325 ml	460 ml	500 ml	
Dimensions	338x138x248 mm	395x145x270 mm	395x145x270mm	
Weight	11.0 Kg	16.6 Kg	17.0 Kg	







Smaller, lighter, and more convenient
Suite for R32, 1234yf refrigerant

Model	V-i2120
Flow Rate	12 CFM
Partial Pressure	2x10 ⁻¹ Pa
Total Pressure	15 micron
Power	1 HP
Inlet Port	1/4" & 3/8" Flare
Oil Capacity	500 ml
Dimensions	345x135x280 mm
Weight	11.5 Kg

• Chinese patent 

VACCUM GAUGE

VACUUM GAUGE	Gauge Diameter	Unit	Assemble	MRP NO.	Thread
	Φ50mm	mbar/inHg	Axial	310500104	NPT1/8"
	Φ50mm	mbar/inHg	Radial	310500106	NPT1/8"
	Φ63mm	mbar/Mpa/Psi	Radial	310500601	NPT1/8"
	Φ75mm	mbar	Axial	310500301	NPT1/8"
	Φ80mm	mbar/Mpa/Psi	Radial	310500405	NPT1/8"

Vacuum Pump Oil

A wide choice of oil is available to obtain the best performance from pumps under different application conditions.

Value Vacuum Pumps can be operated with the oil listed below; using different oil can affect all specified ultimate vacuum and cold starting.



500ml(18 Oz) 330ml(11.5 Oz)

4L(135 Oz) 1L(34 Oz)

Model	VPO-46	VPO-68
Kinematic viscosity(40°C)	41.4-50.6mm ² /s	61.2-74.8mm ² /s
Viscosity Index	110	130
Flash Point	240°C	250°C
Pour Point	-10°C	-35°C
Type	Mineral Oil	Synthetic di-ester oil

EXPLODED VIEW FOR VE N SERIES

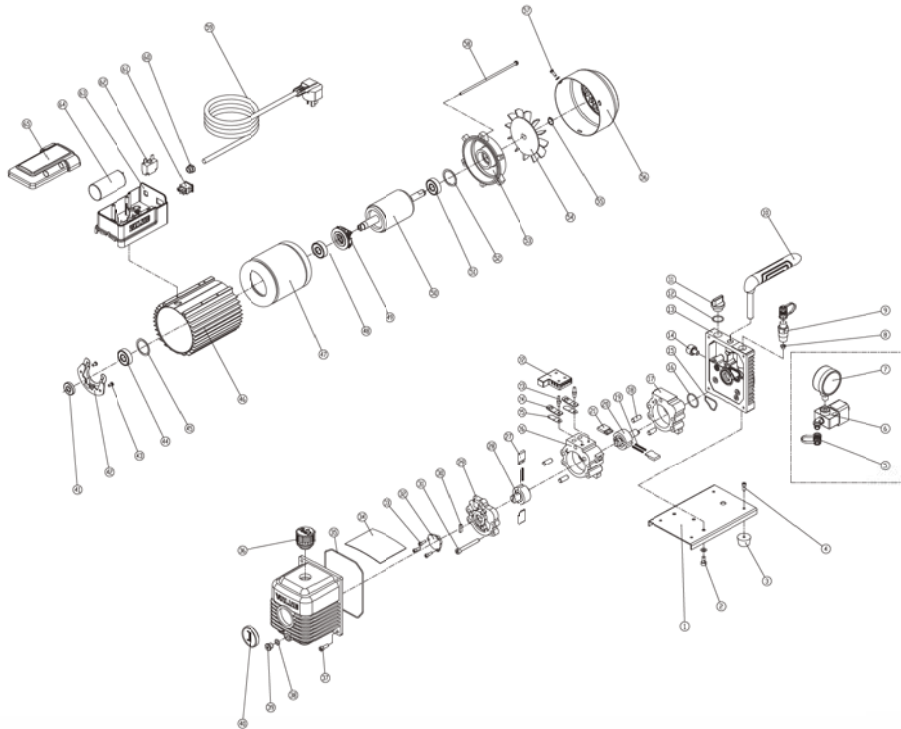

1 Base	17 Fore stator	33 Screw	49 Centrifugal switch
2 Screw	18 Round pin	34 Anti-oil plate	50 Motor rotor
3 Rubber feet	19 Spring	35 O ring	51 Bearing
4 Screw	20 Fore rotor	36 Exhausting and oil inlet fitting	52 Gasket
5 Inlet fitting cap	21 Fore rotary vane	37 Screw	53 Motor cover
6 Solenoid valve	22 Anti-oil cover	38 O ring	54 Fan
7 Vacuum gauge	23 Screw	39 Oil drain plug	55 Elastic collar
8 Filter	24 Control plate	40 Sight glass	56 Fan cover
9 Inlet fitting	25 Displacing valve	41 Seal	57 Cross screw
10 Handle	26 Back stator	42 Centrifugal switch base	58 Cross screw
11 Oil fill cap	27 Back rotary vane	43 Cross screw	59 Power supply cord
12 O ring	28 Back rotor	44 Bearing	60 Insulating bushing
13 Trestle	29 Pump back cover	45 Gasket	61 Power switch
14 Gas ballast	30 Oil pump rotary vane	46 Motor hull	62 Thermal protector
15 O ring	31 Screw	47 Motor stator	63 Junction box
16 O ring	32 Oil pump back cover	48 Bearing	64 Capacitor
			65 Junction box cover

DIMENSION DRAWING

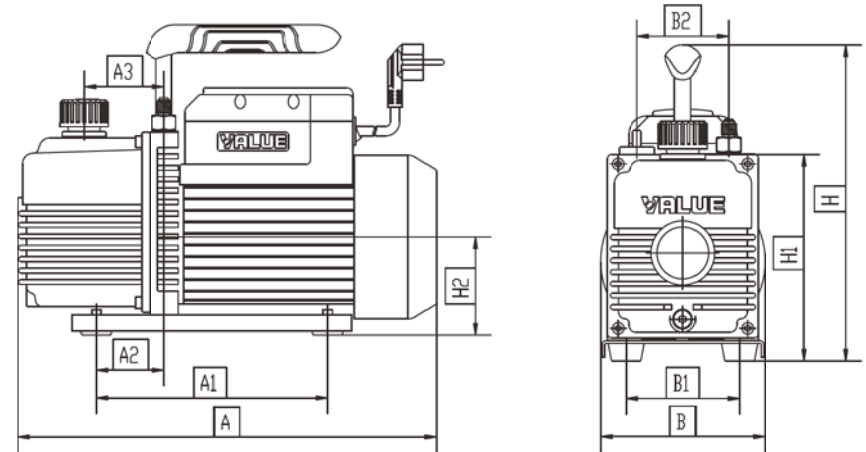

The dimension for VEN series pump(unit:mm)										
Model	A	A1	A2	A3	B	B1	B2	H	H1	H2
VE115N	290	118	30	50	124	76	-	224	141	71
VE125N	290	118	30	50	124	76	-	224	141	71
VE135N	318	144	40	61	124	84	68	234	154	76
VE160N	338	144	40	61	138	84	74	244	166	78
VE180N	395	174	66	85	145	99	74	257	179	86
VE215N	308	118	30	50	124	76	-	224	141	71
VE225N	318	144	40	61	124	84	68	234	154	76
VE245N	338	144	40	61	138	84	74	244	166	78
VE260N	395	174	66	85	145	99	74	257	179	86
VE280N	395	174	66	85	145	99	74	257	179	86
VE2100N	395	174	66	85	145	99	74	257	179	86

NEW REFRIGERANT VACUUM PUMP

Refrigerants category

Vacuum pumps with solenoid valve should be used for pumping new refrigerants. Otherwise, there might be a risk that the pump oil returning to compressor, polluted and destroyed the refrigerants.

	New Refrigerant & Old Refrigerant Vacuum Pump		Old Refrigerant Vacuum Pump	New Refrigerant
	R407C	R22	R22	
R410A	R404A	R12	R12	R32 1234yf
	R507A	R502	R502	
	R134A	R500	R500	

Flow rate











The flow rate of vacuum pump is usually represented by L/S, which means the working time has a direct relationship with the flow rate. It's required to select VALUE high reliable vacuum pumps which matches the equipment.

Flow Rate	1~2L/S	3~4L/S	POWER
Applicable Equipment	Household refrigerator	Central air-conditioning	Central air-conditioning
	Household air-conditioning	Large household air-conditioning	Large household air-conditioning
	Car air-conditioning	Bus air-conditioning Large refrigerated warehouse	

Ultimate vacuum

Ultimate vacuum means the capacity of removing moisture. Pressure unit with Pa usually. The smaller figure, the higher ultimate vacuum achieves. New refrigerants central air-conditioning, Freezing and refrigeration equipment with low evaporator temperature need to use VALUE double stage vacuum pump.

	Single Stage	Dual Stage
Ultimate Vacuum	2Pa	2×10^{-2} Pa
Applicable Equipment	Household air-conditioning	Central air-conditioning
	Car air-conditioning	Large refrigerated warehouse
	Refrigerator	

Adapt for old refrigerant			Adapt for all refrigerant (including R22,R410A,etc...)		Adapt for all refrigerant (including R32,1234yf)
Household air-conditioning Household refrigerator Car air-conditioning	Large household air-conditioning Bus air-conditioning	Central air-conditioning Large refrigerated warehouse	Household air-conditioning	Central air-conditioning Large household air-conditioning	Central air-conditioning Large household air-conditioning
 VE115N(1L/S)	 VE160N(3L/S)	 VE245N(2L/S)	 V-i140SV(2L/S)	 V-i240SV(2L/S)	 V-i240Y-R32 V-i260Y-R32 V-i280Y-R32
 VE135N(2L/S)	 VE180N(4L/S)	 VE280N(4L/S)		 V-i280SV(4L/S)	 V-i2120
150 micron	150 micron	15 micron	150 micron	15 micron	15 micron

ACCESSORY

AC Power Supply Plug

Item	Description
C01	Israel plug
C02	China plug
C03	Australia plug
C04	South Africa plug
C05	Europe plug
C06	America plug
C07	Britain plug
C08	Japan plug
C09	Italy plug
C10	Argentina plug
C11	Brazil plug



C01



C02



C03



C04



C05



C06



C07



C08



C09



C10



C11

Intake Ports Adapter



Item	Description
T2	1/4" SAE
T3	1/4" SAE & 3/8 SAE
T4	1/4" SAE & 1/2" Acme
T5	1/4" Tube
T6	1/4" Tube(Locked with M12 x1 nut)
TG3	1/4" SAE Vacuum Gauge

INDUSTRIAL SERIES

VRD SERIES

Excellent Performance

Suitable for production line



Adjustable gas ballast valve



Oil anti-sucking



Internal forced oil cycling system, more reliable



The integrated cylinder structure



Specification

Model		VRD-16	VRD-24	VRD-30
Displacement speed m ³ /h	50 Hz	16 (4.4)	24(6.6)	30(8.3)
	60 Hz	19.2 (5.2)	28.8 (7.9)	36 (9.9)
Ultimate partial pressure gas ballast close		4x10 ⁻² Pa	4x10 ⁻² Pa	4x10 ⁻² Pa
Ultimate partial pressure gas ballast close		4x10 ⁻¹ Pa	4x10 ⁻¹ Pa	4x10 ⁻¹ Pa
Ultimate partial pressure gas ballast close		8x10 ⁻¹ Pa	8x10 ⁻¹ Pa	8x10 ⁻¹ Pa
Power supply		single/3-ph	single/3-ph	single/3-ph
Power rating(kw)		0.75kW/0.55kW	1.1kW/0.75kW	1.1kW
Inlet and exhaust DN		KF25	KF25/40	KF25/40
Oil capacity(L)		0.9~1.5L	1.3~2.0L	1.3~2.0L
Motor speed (rpm)	50 Hz	1440	1440	1440
	60 Hz	1720	1720	1720
Ambient temperature		5~40°C	5~40°C	5~40°C
Noise level (dB)		≤58	≤58	≤58
Weight(Kg)		33Kg	36Kg	37Kg

INDUSTRIAL VACCUM PUMP

POWER SERIES

Powerful Fast

Suitable for large engineering equipment, refrigeration equipment and the other vacuum work



The integrated



Six air inlets design



Oil anti-sucking



Internal forced oil cycling system, more reliable



Specification

Model		VP2120	VP2200
Displacement speed m ³ /h (CFM)	50 Hz	20(12)	36(20)
	60 Hz	24(14)	43(24)
Ultimate partial pressure gas ballast close		4x10 ⁻² Pa	4x10 ⁻² Pa
Ultimate partial pressure gas ballast close		4x10 ⁻¹ Pa	4x10 ⁻¹ Pa
Ultimate partial pressure gas ballast close		8x10 ⁻¹ Pa	8x10 ⁻¹ Pa
Power supply		single/3-ph	single/3-ph
Power rating(kw)		0.75/0.55kW	1.1/0.75kW
Inlet and exhaust DN		7/16"-20UNF	7/16"-20UNF
Oil capacity(L)		0.9~1.5L	1.3~2.0L
Motor speed (rpm)	50 Hz	1440	1440
	60 Hz	1720	1720
Ambient temperature		5~40°C	5~40°C
Noise level (dB)		≤58dB	≤58
Weight(Kg)		37Kg	41Kg

RECOVERY UNIT



Work status indication lamps



One-key operation more convenient



Start switch



Oil-less input/ Output gauge



Optional 80% over filled protection



Digital gauge



Work status indication lamps



One-key operation more convenient



Basket handle



Optional 80% over filled protection

M SERIES RECOVERY UNIT



• Chinese patent

VRR12M

Smaller, lighter, and more convenient

Suit for R32 1234yf refrigerant

- Brushless motor, energy saving
- One key operation, easy to use
- Digital gauge, easy to read
- Equipped with high, low pressure protection
- self-purge function
- One-piston, brushless DC motor 3/4HP

Only 7.8kg



VRR24M

Suit for R32 1234yf refrigerant

- Brushless motor, energy saving
- One key operation, easy to use
- Digital gauge, easy to read
- Equipped with high, low pressure protection
- self-purge function
- Two-piston, brushless DC motor 1HP

Only 10kg

Specifications

Model	VRR12M			VRR24M		
Refrigerants	Categories III : R12,R134a,R401C,R500,1234yf Categories IV : R22,R401A, R401B, R402B, R407C, R407D, R408A,R409A,R411A R411B,R412A,R502,R509 Categories V : R402A,R404A,R407A,R407B,R410A,R507,R32					
Power Supply	220-240V~/50-60Hz	115V~/60Hz		220-240V~/50-60Hz	115V~/60Hz	
Motor	Brushless DC motor 3/4 HP			Brushless DC motor 1 HP		
Motor Speed	3000rpm			3000rpm		
Maximal Current Draw	2.6A	5.5A		5A	9 A	
Compressor	Oil-less, Air-cooled, Piston style					
Automatic safety Shut-Off	38.5bar/3850kPa(558psi)					
Recovery Rate (Kg/min)	Category III	Category IV	Category V	Category III	Category IV	Category V
	Vapor	0.20	0.25	0.25	0.40	0.50
	Liquid	1.76	1.98	2.42	3.30	3.85
	Push/pull	4.60	5.60	6.30	7.50	8.50
Operating Temperature	0 °C~40 °C					
Dimensions	304×202×260 mm			380×250×360 mm		
Weight	7.8 Kg			10Kg		

L SERIES RECOVERY UNIT

L SERIES RECOVERY UNIT



Mini Recovery Unit
VRR12L-R32

- Suitable for 1234yf and r32 refrigerant
- One key operation, easy to use
- No spark



Mini Recovery Unit
VRR24L-R32

- Suitable for 1234yf and R32 refrigerant
- One key operation, easy to use
- No spark

Special Designed
Power Button



Special Designed
Power Button



VRR12LOS-R32

- Suitable for 1234yf and r32 refrigerant
- Purification and recycling of the refrigerants



VRR24LOS-R32

- Suitable for 1234yf and r32 refrigerant
- Purification and recycling of the refrigerants

Specifications

Model	VRR12L-R32		VRR12LOS-R32				
Refrigerants	Category III: R12,R134a,R401C,R500,1234yf						
	Category IV: R22,R401A, R401B, R402B, R407C, R407D, R408A,R409A,R411A,R411B,R412A,R502,R509						
	Category V: R402A,R404A,R407A,R407B,R410A,R507,R32						
Power Supply	220V-240V~/50-60Hz	115V~/60Hz	220V-240V~/50-60Hz	115V~/60Hz			
Motor	3/4 HP	3/4 HP	3/4 HP	3/4 HP			
Motor Speed	1450rpm/1750rpm	1750rpm	1450rpm/1750rpm	1750rpm			
Maximal Current Draw	4A	8A	4A	8A			
Compressor	Oil-less, Air-cooled, Piston style						
Automatic safety Shut-Off	38.5bar/3850kPa(558psi)						
Recovery Rate (Kg/min)		Category III	Category IV	Category V	Category III	Category IV	Category V
	Vapor	0.20	0.25	0.25	0.20	0.25	0.25
	Liquid	1.60	1.80	2.20	1.60	1.80	2.20
	Push/pull	4.60	5.60	6.30	4.60	5.60	6.30
Operating Temperature	0°C~40°C						
Dimensions	450*250*355mm						
Weight	13.0 Kg		14.2 Kg				

Specifications

Model	VRR24L-R32		VRR24LOS-R32				
Refrigerants	Category III: R12,R134a,R401C,R500,1234yf						
	Category IV: R22,R401A, R401B, R402B, R407C, R407D, R408A,R409A,R411A,R411B,R412A,R502,R509						
	Category V: R402A,R404A,R407A,R407B,R410A,R507,R32						
Power Supply	220V-240V~/50-60Hz	115V~/60Hz	220V-240V~/50-60Hz	115V~/60Hz			
Motor	1 HP	1 HP	1 HP	1 HP			
Motor Speed	1450rpm/1750rpm	1750rpm	1450rpm/1750rpm	1750rpm			
Maximal Current Draw	5A	10A	5A	10A			
Compressor	Oil-less, Air-cooled, Piston style						
Automatic safety Shut-Off	38.5bar/3850kPa(558psi)						
Recovery Rate (Kg/min)		Category III	Category IV	Category V	Category III	Category IV	Category V
	Vapor	0.40	0.50	0.50	0.40	0.50	0.50
	Liquid	3.00	3.50	3.50	3.00	3.50	3.50
	Push/pull	7.50	8.50	9.50	7.50	8.50	9.50
Operating Temperature	0°C~40°C						
Dimensions	450*250*355mm						
Weight	13.5 Kg		14.7 Kg				

L SERIES RECOVERY UNIT



• Chinese patent

Mini Recovery Unit
VRR12L

One Key Operation

- One key operation, easy to use
- Equipped with high pressure protection
- Oil-less compressor
- Self-purge function
- 13.0Kg, easy to carry



VRR12L-OS

One Key Operation

- Oil separator device
- Purification and recycling of the refrigerants

Specifications

Model	VRR12L		VRR12LOS				
Refrigerants	Category III: R12,R134a,R401C,R500						
	Category IV: R22,R401A, R401B, R402B, R407C, R407D, R408A,R409A,R411A R411B,R412A,R502,R509						
	Category V: R402A,R404A,R407A,R407B,R410A,R507						
Power Supply	220V-240V~/50-60Hz	115V~/60Hz	220V-240V~/50-60Hz	115V~/60Hz			
Motor	3/4 HP	3/4 HP	3/4 HP	3/4 HP			
Motor Speed	1450rpm/1750rpm	1750rpm	1450rpm/1750rpm	1750rpm			
Maximal Current Draw	4A	8A	4A	8A			
Compressor	Oil-less, Air-cooled, Piston style						
Automatic safety Shut-Off	38.5bar/3850kPa(558psi)						
Recovery Rate (Kg/min)		Category III	Category IV	Category V	Category III	Category IV	Category V
	Vapor	0.20	0.25	0.25	0.20	0.25	0.25
	Liquid	1.60	1.80	2.20	1.60	1.80	2.20
	Push/pull	4.60	5.60	6.30	4.60	5.60	6.30
Operating Temperature	0°C~40°C						
Dimensions	450×250×355mm						
Weight	13.0 Kg			14.2 Kg			

L SERIES RECOVERY UNIT



• Chinese patent

Mini Recovery Unit
VRR24L

Lighter • Faster

- One key operation, easy to use
- Equipped with high pressure protection
- 80% over filling protection
- Twin-piston, oil-less compressor, faster recovery
- Self-purge function



VRR24L-OS

Lighter • Faster

- Oil separator device
- Purification and recycling of the refrigerants

Specifications

Model	VRR24L		VRR24L-OS				
Refrigerants	Category III: R12,R134a,R401C,R500						
	Category IV: R22,R401A, R401B, R402B, R407C, R407D, R408A,R409A,R411A R411B,R412A,R502,R509						
	Category V: R402A,R404A,R407A,R407B,R410A,R507						
Power Supply	220V-240V~/50-60Hz	115V~/60Hz	220V-240V~/50-60Hz	115V~/60Hz			
Motor	1 HP	1 HP	1 HP	1 HP			
Motor Speed	1450rpm/1750rpm	1750rpm	1450rpm/1750rpm	1750rpm			
Maximal Current Draw	5A	10A	5A	10A			
Compressor	Oil-less, Air-cooled, Piston style						
Automatic safety Shut-Off	38.5bar/3850kPa(558psi)						
Recovery Rate (Kg/min)		Category III	Category IV	Category V	Category III	Category IV	Category V
	Vapor	0.40	0.50	0.50	0.40	0.50	0.50
	Liquid	3.00	3.50	3.50	3.00	3.50	3.50
	Push/pull	7.50	8.50	9.50	7.50	8.50	9.50
Operating Temperature	0°C~40°C						
Dimensions	450×250×355mm						
Weight	13.5 Kg			14.7 Kg			

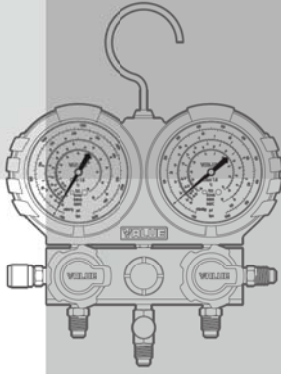

Refrigerant Tools

Accurate

MANIFOLD GAUGE



Special material sheath with anti-collision performance



High precision pressure gauge with class 1.6 accuracy



Metal-embedded designed valve to increase strength

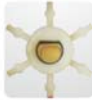

Φ12mm high-strength rubber tube to ensure high reliability



Model	VMG-2-R32
Refrigerant scale	R32
Gauge Diameter	Φ80mm
Pressure Scale	0~80 psi; -30~500 psi
Hose	Red&Blue: 1/4"-5/16", 2x1pc Yellow: 1/4"-1/4", 1pc
Length	150cm
Package	Blow Case



Model	VMG-2-1234yf
Refrigerant scale	1234yf
Gauge Diameter	Φ80mm
Pressure Scale	0~400 psi; -30~130 psi
Hose	Red&Blue: M12X1.5 - M12X1.5, 2X1pc Yellow: M12X1.5 - 1/2", 1pc
Length	150cm
Package	Blow Case

MANIFOLD GAUGE



VMG-2-R410A



VMG-2-R410A-02



VMG-2-R410A-03



VMG-2-R410A-04



VMG-2-R410A-05

Model	VMG-2-R410A	VMG-2-R410A-02	VMG-2-R410A-03	VMG-2-R410A-04	VMG-2-R410A-05
Refrigerants scale	R410A	R410A/R407C/R22/R134a			R410A/R407C/R404A/R134a
Gauge Diameter	Φ80 mm				
Pressure Scale	0~800 psi; -30~500 psi				
Hose	Red&Blue: 1/4"-5/16", 2x1pc Yellow: 1/4"-1/4", 1pc	Red&Blue: 1/4"-5/16", 2x1pc Yellow: 1/4"-1/4", 1pc With 2pcs adapters	Red&Blue: 1/4"-5/16", 2x1pc Yellow: 1/4"-1/4", 1pc	/	Red&Blue: 1/4"-5/16", 2x1pc Yellow: 1/4"-1/4", 1pc
Standard Length	150 cm				
Package	Blow case		Blister packing	Blister packing	Blister packing

NOTICE: All information listed above is standard size, if you require other size, please appoint in the order.



VMG-2-R410A-B



VMG-2-R410A-B-02



VMG-2-R410A-B-03

Model	VMG-2-R410A-B	VMG-2-R410A-B-02	VMG-2-R410A-B-03
Refrigerants scale	R410A/R407C/R22/R134a		
Gauge Diameter	Φ68 mm		
Pressure Scale	0~800 psi; -30~500 psi		
Hose	Red&Blue: 1/4"-5/16", 2x1pc Yellow: 1/4"-1/4", 1pc	/	
Standard Length	120 cm		
Package	Blow case	Blister packing	Blister packing

NOTICE: All information listed above is standard size, if you require other size, please appoint in the order.

MANIFOLD GAUGE



VMG-2-R22



VMG-2-R22-02



VMG-2-R22-03

Model	VMG-2-R22	VMG-2-R22-02	VMG-2-R22-03
Refrigerants scale	R404A/R407C/R134a/R22		
Gauge Diameter	Φ80mm		
Pressure Scale	0~400psi; -30~140psi		
Hose	Red&Blue&Yellow: 1/4"-1/4", 3x1pc		/
Standard Length	120cm		
Package	Blow Case	Blister packing	Blister packing

NOTICE: All information listed above is standard size, if you require other size, please appoint in the order.



VMG-2-R22-B



VMG-2-R22-B-02



VMG-2-R22-B-03

Model	VMG-2-R22-B	VMG-2-R22-B-02	VMG-2-R22-B-03
Refrigerants scale	R404A/R407C/R134a/R22		
Gauge Diameter	Φ68mm		
Pressure Scale	0~400psi; -30~140psi		
Hose	Red&Blue&Yellow: 1/4"-1/4", 3x1pc		/
Standard Length	120cm		
Package	Blow Case	Blister packing	Blister packing

NOTICE: All information listed above is standard size, if you require other size, please appoint in the order.

MANIFOLD GAUGE



VMG-2-R134a



VMG-2-R134a-02

Model	VMG-2-R134a	VMG-2-R134a-02
Refrigerants scale	R134a	
Gauge Diameter	Φ80mm	
Pressure Scale	0~400psi; -30~140psi	
Hose	Red&Blue&Yellow: 1/4"-1/4", 3x1pc	Red&Blue: 1/2"Acme,M14×1.5, 2×1pc Yellow: 1/2"Acme, 1/2"Acme, 1pc
Standard Length	120cm	
Package	Blow Case	
Quick Couplers	VHF-SA 1set	VHF-SB 1set

NOTICE: All information listed above is standard size, if you require other size, please appoint in the order.



VMG-2-R134a-B



VMG-2-R134a-B-02

Model	VMG-2-R134a-B	VMG-2-R134a-B-02
Refrigerants scale	R134a	
Gauge Diameter	Φ68 mm	
Pressure Scale	0~400psi; -30~140psi	
Hose	Red&Yellow&Blue: 1/4"-1/4", 3×1pc	Red&Blue: 1/2"Acme,M14×1.5, 2×1pc Yellow: 1/2"Acme, 1/2"Acme, 1pc
Standard Length	120 cm	
Package	Blow case	
Quick Couplers	VHF-SA 1set	VHF-SB 1set

NOTICE: All information listed above is standard size, if you require other size, please appoint in the order.

MANIFOLD GAUGE



Special material sheath with anti-collision performance



3/8" port for large system



Sight glass to easily view refrigerant movement and condition



Hose holder fitting 5/16"-1/4"-3/8"-5/16"



Model	VMG-4-R410A
Refrigerants scale	R410A
Gauge Diameter	Φ80 mm
Pressure Scale	0~800 psi; -30~500 psi
Hose	Red&Blue: 1/4"-5/16", 2x1pc 150cm with check valve Yellow: 1/4"-1/4", 1pc 150cm Black: 3/8"-3/8", 1pc 150cm
Package	Blow case

SINGLE GAUGE

Accurate Single Gauge

Suitable for R401A, R134a, R12, R22, R407C, R404A

Accurate Anti-Collision

- Pressure gauge with high precision movement, precision grade 1.6
- High strength rubber cover, fully anti-collision
- The gauge handle with metal insert with increase the strength



VMG-1-U-H

VMG-1-U-L



VMG-1-S-H

VMG-1-S-L

Specifications

Model	VMG-1-U-H	VMG-1-U-L	VMG-1-S-H	VMG-1-S-L
Gauge Diameter	Φ68mm			
Refrigerants scale (Optional)	ABH/ABL	R134a		
	BBH/BBL	R22/R134a/R404A/R407C		
	CBH/CBL	R22/R134a/R410A/R407C		
	DBH/DBL	R410A		
	EBH/EBL	R404A/R134a/R410A/R407C		
Pressure Scale	-30inHg~800psi	-30inHg~500psi	-30inHg~800psi	-30inHg~500psi
Sight glass	Without		With	
Package	Blister packing		Blister packing	

PRESSURE GAUGE

High / Low Pressure Gauge	Gauge Diameter	Unit	Refrigerant	MRP NO.	Thread
 <p>ABH ABL</p>	Φ68mm	°C/°F/ Pis/Bar	R134a	342260108 342260109	NPT1/8"
 <p>BBH BBL</p>	Φ68mm	°C/Psi/Bar	R22 R134a R404A R407C	342260110 342260111	NPT1/8"
 <p>CBH CBL</p>	Φ68mm	°C/Psi/Bar	R22 R134a R410A R407C	342260112 342260113	NPT1/8"
 <p>DBH DBL</p>	68mm	°C/°F/ Psi/Bar	R410A	342260114 342260115	NPT1/8"
 <p>EBH EBL</p>	Φ68mm	°C/Psi/Bar	R404A R134a R410A R407C	342260118 342260119	NPT1/8"

PRESSURE GAUGE

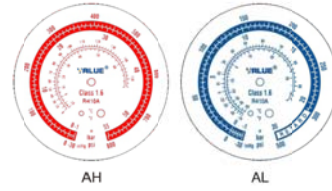
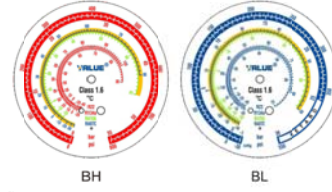
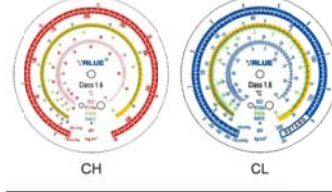
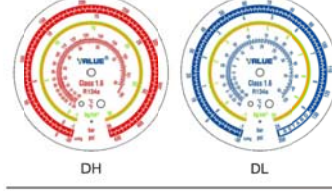
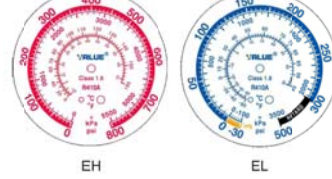
High / Low Pressure Gauge	Gauge Diameter	Unit	Refrigerant	MRP NO.	Thread
 <p>AH AL</p>	Φ80mm	°C/°F/Pis/Bar	R410A	342260101 342260102	NPT1/8"
 <p>BH BL</p>	Φ80mm	°C/Psi/Bar	R22 R134a R410A R407C	342260104 342260105	NPT1/8"
 <p>CH CL</p>	Φ80mm	°C/Psi/ kg/cm ²	R22 R134a R404A R407C	342260401 342260402	NPT1/8"
 <p>DH DL</p>	80mm	°C/°F/Psi/ Barkg/cm ²	R410A	342260405 342260406	NPT1/8"
 <p>EH EL</p>	Φ80mm	°C/°F/ Psi/kPa	R410A	342260409 342260410	NPT1/8"

PRESSURE GAUGE

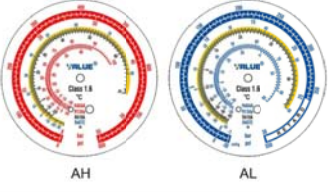
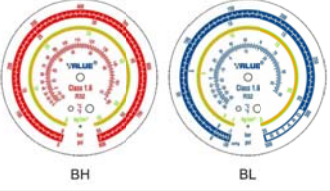
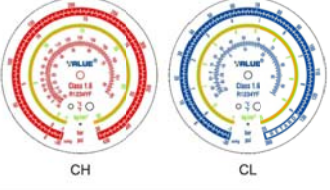
High / Low Pressure Gauge	Gauge Diameter	Unit	Refrigerant	MRP NO.	Thread
 <p>AH AL</p>	Φ80mm	°C/Bar/Psi	R404A R134a R410A R407C	342260411 342260412	NPT1/8"
 <p>BH BL</p>	Φ80mm	°C/°F/Psi/ Bar/kg/cm ²	R32	342260413 342260414	NPT1/8"
 <p>CH CL</p>	Φ80mm	°C/°F/Psi/ Bar/kg/cm ²	1234yf	342260415 342260416	NPT1/8"

DIGITAL MANIFOLD GAUGE



Accurate Digital Manifold Gauge VDG-2-S1

- Built-in 9 refrigerant: R22, R32, R290, R410A, 1234yf, R134a, R404A, R407C, R507
- Pressure Display: psi, bar, KPa, MPa, kg/cm²
- Temperature Display: °C °F
- Vacuum Display: inHg
- Sensing Accuracy: 0.75% FS
- Sensing Resolution: 1psi
- Hose: Red&Blue: 1/4"-5/16, 2x1pc
Yellow: 1/4"-1/4". 1pc
- Package: Blow Case



Accurate Digital Manifold Gauge VDG-4-S1

- Built-in 9 refrigerant: R22, R32, R290, R410A, 1234yf, R134a, R404A, R407C, R507
- Pressure Display: psi, bar, KPa, MPa, kg/cm²
- Temperature Display: °C °F
- Vacuum Display: inHg
- Sensing Accuracy: 0.75% FS
- Sensing Resolution: 1psi
- Hose: Red&Blue: 1/4"-5/16, 2x1pc
Yellow: 1/4"-1/4". 1pc
Black: 3/8"-3/8" SAE
- Package: Blow Case

DIGITAL MANIFOLD GAUGE

Accurate Digital Manifold Gauge VDG-1

- Suitable for detecting 44 refrigerant
- Built-in 9 refrigerant: R11, R123, R404A, R414B, R66A, R428A, R12, R124, R406A, R744, R426A, R417A, R13, R134a, R407A, R422A, 1234yf, R437A, R22, R290, R407C, R422D, R424A, R23, R410A, R408A, R427A, R434A, R728, R32, R401B, R409A, R502, R422B, R113, R402A, R410A, R507A, R416A, R114, R402B, R413A, R508B, R402A
- Including clamp probe for temperature measurement
- Measuring range pressure: 0~725psi
- Operating temperature: 10~90% RH
- Weight 1.2 kg



Accurate Digital Manifold Gauge VDG-S1

- Built-in 9 refrigerant: R22, R32, R290, R410A, 1234yf, R134a, R404A, R407C, R507
- Pressure Display: psi, bar, KPa, MPa, kg/cm²
- Temperature Display: °C °F
- Vacuum Display: inHg
- Sensing Accuracy: 0.75% FS
- Sensing Resolution: 1psi
- Refrigerant Temperature: -5~50°C
- Connection: 1/4" SAE
- Power: 9V DC battery 50 hours pressure and temperature mode only(continuous use)



ACCESSORY

Refrigerant Tube High Strength

- General: suitable for R410A, R134a, R12, R22 refrigerant
- Safe: Rubber tube wall is thickened and the diameter is up to 12mm, to ensure the safety and reliability during the use
- Anti-leakage: High oil resistances, anti-leakage, reach to RMA-A level



Model	Connector Size		
	R410A	R134a R22 R12	R134a
Pressure Scale	~800 psi		~800psi; ~500psi
VRP-U-R	1/4"-5/16"	1/4"-1/4"	1/2"Acme M14×1.5
VRP-U-Y	1/4"-1/4"	1/4"-1/4"	1/2"Acme 1/2"Acme
VRP-U-B	1/4"-5/16"	1/4"-1/4"	1/2"Acme M14×1.5
Lenth	90 cm	120 cm	150 cm

Model	Connector Size		
	R410A	R134a R22 R12	R134a
Pressure Scale	~800 psi		
VRP-C-R	1/4"-5/16"	1/4"-1/4"	1/2"Acme M14×1.5
VRP-C-Y	1/4"-1/4"	1/4"-1/4"	1/2"Acme 1/2"Acme
VRP-C-B	1/4"-5/16"	1/4"-1/4"	1/2"Acme M14×1.5
Lenth	90 cm	120 cm	150 cm
Check valve	1set(Optional: CV01-CV06)		

Quick Couplers

VHF SERIES

Suitable for refrigerant R134a, etc.
Automotive air conditioning maintenance tool



VHF-SA



VHF-SB



VHF-SC

Safety and Reliable

- Connecting pipeline of car air-conditioning and refrigerant system very fast
- Controlling the pipeline's open and close

Model	VHF-SA	VHF-SB	VHF-SC
Description	1/4" SAE	M14×1.5	3/8" SAE

ACCESSORY

Check Valve



CV01



CV02



CV03



CV04



CV05



CV06



CV07



CV08



CV09



CV10



CV11



CV12

Item	Description	Item	Description
CV01	Male: 1/4"SAE Female: 5/16" SAE	CV07	Male: 1/4"SAE Female: 1/4" SAE
CV02	Male: 1/4"SAE Female: 5/16" SAE 45°	CV08	Male: 5/16"SAE Female: 5/16" SAE 45°
CV03	Male: 1/4"SAE Female: 5/16" SAE 60°	CV09	Male: 5/16"SAE Female: 5/16" SAE 60°
CV04	Male: 5/16"SAE Female: 5/16" SAE	CV10	Male: 5/16"SAE Female: 1/4" SAE
CV05	Male: 1/4"SAE Female: 1/4" SAE 45°	CV11	Male: 5/16"SAE Female: 1/4" SAE 45°
CV06	Male: 1/4"SAE Female: 1/4" SAE 60°	CV12	Male: 5/16"SAE Female: 1/4" SAE 60°

Adapter



V01



V02



V03



V04



V05



V06



V07



V08

Item	Description	Item	Description
V01	Male: 5/16"SAE 90° Female: 5/16" SAE	V05	Male: 1/4"SAE 90° Female: 5/16" SAE
V02	Male: 1/4"SAE 90° Female: 5/16" SAE	V06	Male: 5/16"SAE 90° Female: 1/4" SAE
V03	Male: 5/16"SAE 90° Female: 1/4" SAE	V07	Male: 5/16"SAE 90° Female: 5/16" SAE
V04	Male: 1/4"SAE 90° Female: 1/4" SAE	V08	Male: 5/16"SAE 90° Female: 1/4" SAE

LEAK DETECTOR

VLD-1

Accurate Detect

- With three different sensiliveness
- High sensitivity
- Fast response
- suit for different refrigerants



Specification

Battery :	4X1.5V AABattery
Battery life :	4hours
Sensitivity :	10ppm
Sensor life :	1year(normal use)
Ambit temperature :	0-50°C
Calibration:	Automatic
Respond time :	2Second
Probe length :	300mm
Dimension :	230mmX83mmx50mm
Weight :	220g

Refrigerants

R11/R123/R404A/R414B/R600AR12/R428A/R407A/R406A
 R744/R426A/R417A/R13/R134a/R422D/R422A/1234yf
 R437A/R22/R290/R407C/R728/R424A/R23/R401A/R408A
 R427AR434A/R410A/R401B/R409A/R502/R422B/R113/R402A
 R32/R124/R507A/R416A/R114/R402B/R413A/R508B/R420A

SCALE







VES-50A/VES-100A



VES-50B/VES-100B

Quantitative filling precision control

Easy operation schematic

- 1 Open the electrical scale 
- 2 Place the refrigerant tank and clear the electrical scale 
- 3 Enter the filling and recovery function, enter the net weight values of the refrigerant, and press Enter 
- 4 When close to fixing weight of filling/recovery, electronic scale will alarm or automatic shut down the valve, and prompts the filling/recovery has been completed 
- 5 After filling/recovery, stop the scale manually, and press Enter 

SCALE



VES-50A/VES-100A

Quantitative Filling Precision Control
Easy Operation Schematic

Anti-collision



The recovery/
recycling weight can be set,
convenient for operation



Model	VES-50A	VES-100A
Weighting range	50Kg	100Kg
Resolution	2 g	5 g
Accuracy	±0.05%	
Display	LCD	
Power	DC 9V, at least 80h working time	
Working environment	-10°C~40°C, ≤75% Humidity	
Platform size	237×237 mm	
Weight	5 Kg	
Anti-collision	Yes	



VES-50B/VES-100B

Quantitative Filling Precision Control
Easy Operation Schematic

High precision valve,
accuracy control,
filling weight ± 20g



Anti-collision



The recovery/
recycling weight can be set,
convenient for operation



Model	VES-50B	VES-100B
Weighting range	50Kg	100Kg
Resolution	2 g	5 g
Accuracy	±0.05%	
Display	LCD	
Power	DC9V& AC(110V~240V)	
Working environment	-10°C~40°C, ≤75% Humidity	
Platform size	237×237 mm	
Weight	6.5 Kg	
Anti-collision	Yes	
Automatic shut-off	Yes	

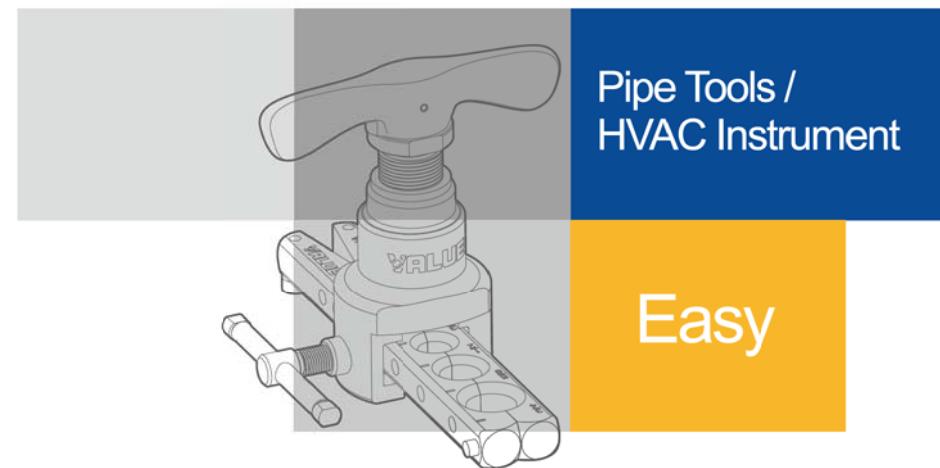

Pipe Tools /
HVAC Instrument

Easy

FLARING TOOL

FLARING TOOL



VFT-808

Accurate Tube Flaring

- 45° eccentric flaring tool in metric and inch sizes
- Heavy duty wide-range bar type flaring tool
- Hardened bars provide positive clamping action with minimum distortion
- Easy to use and exact flaring result

Annular rivet connection



Steel ball positioning, convenient flaring



• Chinese patent

Operation



VFT-808-I

VFT-808-I-02

VFT-808-MI

VFT-808-MI-02

Model	Tube O.D.	Applicable pipe	Packaging
VFT-808-I	1/4", 5/16", 3/8", 1/2", 5/8", 3/4"	Copper pipe	Blow case
VFT-808-I-02			Carton
VFT-808-MI	6, 8, 10, 12, 16, 19mm		Blow case
VFT-808-MI-02	1/4", 5/16", 3/8", 1/2", 5/8", 3/4"		Blow case



VFT-808-IS

VFT-808-MIS

VFT-808-IE

Model	Tube O.D.	Tube Tool	Applicable pipe	Packaging
VFT-808-IS	1/4", 5/16", 3/8", 1/2", 5/8", 3/4"	VTC-28B	Copper pipe	Blow case
VFT-808-MIS	6, 8, 10, 12, 16, 19mm 1/4", 5/16", 3/8", 1/2", 5/8", 3/4"	VTC-28B		Blow case
VFT-808-IE	1/4", 5/16", 3/8", 1/2", 5/8", 3/4"	VST-22		Blow case

FLRING TOOL



VFT-809

Accurate Tube Flaring

- Easy operation, save time and
- special design for R410A system
- The special cone eccentric revolution will allow the internal opening gradually and form 45° accurately and regularly, prevent the tube slippage downward. Therefore, the flaring face will be smooth, uniform without scratching.
- Eccentric cone will rebound by itself after the work is finished. To make the idle top head in revolution again for 1-2 more rounds, with the friction the flaring face will be more smooth and prettier.

• Chinese patent



VFT-809-I



VFT-809-IS

Model	Tube O.D.	Tube Cutter	Packaging
VFT-809-I	1/4", 5/16", 3/8", 1/2", 5/8", 3/4"	/	Blow case
VFT-809-IS	1/4", 5/16", 3/8", 1/2", 5/8", 3/4"	VTC-28B	

FLRING TOOL



VFT-808C

Axial Spacing Accurate Tube Flaring

- Axial spacing to ensure the accurate size
- Innovative patent clamping structure for convenient operation
- Innovative design, operating more humane

• Chinese patent



VFT-808C

Model	Tube O.D.	Tube Cutter	Packaging
VFT-808C	1/4", 5/16", 3/8", 1/2", 5/8", 3/4"	/	Blow case

Axial spacing
Accurate tube flaring



Convenient loading and
unloading Quick clamping



FLIRING TOOL

Elctrical Flaring Tool

VET-19-S

Quick Flaring

- 5-second fast and accurate flaring
- Single head, easy to use for small space
- Not limited by environment condition



• Chinese patent 

Operation

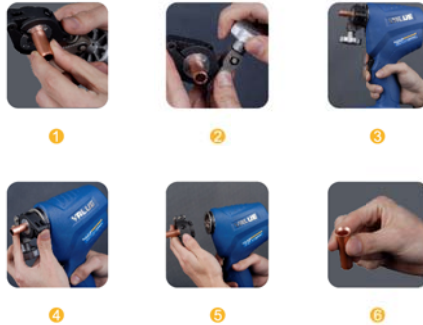

Specification

Power supply :	DC motor
Applicable Pipe :	Copper pipe
Tube O.D. :	1/4", 5/16", 3/8", 1/2", 5/8", 3/4"
Flaring shape :	Flared
Tuber cutter:	VTC-28B
Deburring tool:	VTT-5
Weight :	5.8Kg



BENDING TOOL



VBT-1

Three in One

- Using high quality aluminium, light weight, easy to bring with
- Adjustable hook
- Human factor designed handle makes bending easy

Specification

Model	VBT-1
Bending Size	1/2", 3/8", 1/4"
Bending Radius	1-1/2", 1-1/8", 11/16"
Bending Angle	0~180°
Applicable Material	All soft pipes, thin-wall copper pipes and annealed treated hard pipe



VBT-3/4/5

Easy Bending

- Twin roller design reduces the friction, makes the bending more convenient
- Human factor designed two-period bending, makes big angle bending easy
- Unique pre-deformation design, ensures the tube's eveness and quality

Specification

Model	VBT-3	VBT-4	VBT-5
Bending Size	5/8", 16mm	3/4", 19mm	7/8", 22mm
Bending Radius	2-1/4"	3"	3-1/4"
Bending Angle	0~180°		
Applicable Material	All soft pipes, thin-wall copper pipes and annealing treated hard pipe		

TUBE EXPANDER



VST-22 Easy to Carry

Invention patent
Using the most simple structure for brass pipe expanding



Tube O.D.: 3/8", 1/2", 5/8", 3/4", 7/8"

• Chinese patent

Patent for invention



TUBE CUTTER

Sharp Tube Cutter

- Grinding blade, uses high-quality alloy tool steel, grinding process
- Unique ball bearing design, easy cutting



• Chinese patent

VTC-28B/32/42/70



VTC-19/28

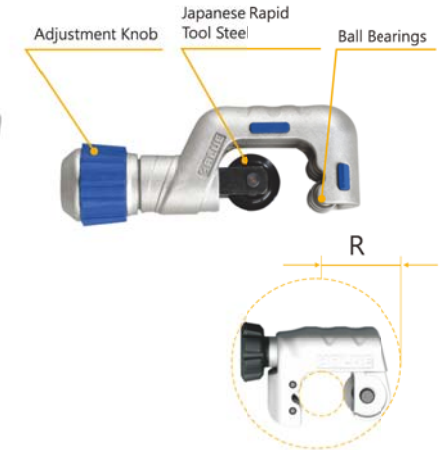

Model	Description
VTC-19	For 1/8"~3/4" (3~19mm)
VTC-28	For 1/8"~1-1/8" (4~28mm)
VTC-28B	For 1/8"~1-1/8" (4~28mm)
VTC-32	For 1/8"~1-1/4" (4~32mm)
VTC-42	For 1/4"~1-5/8" (6~42mm)
VTC-70	For 1/4"~2-5/8" (6~67mm)

DEBURRING TOOL



VTT-5

- Well polished surface. Compared with other deburring tools, VALUE deburring tool adopts sharp cutting edge, provide you a better finish.
- Easy to use and saving cost. VALUE deburring tool is convenient to carry with, and easy to change blade.



- Two extra blades in side
- Easy to change the blade by push the button



TOOL KIT



VTB-5A

Complete with	Description	Quantity
Vacuum pump	1.5CFM	1pc
Flaring tool	VFT-808-I	1set
Tube cutter	VTC-28B	1pc
Scraper	VTT-5	1pc
Manifold gauge	VMG-2-R410A	1set
Tube expanders	VST-22	1pc
Package	Aluminum alloy box	1pc



TOOL KIT



VTB-5B- I

Complete with	Description	Quantity
Flaring tool	VFT-808-I	1set
	VTC-28B	1pc
Tube cutter	VTC-19	1pc
	VTC-19	1pc
Manifold gauge	VMG-2-R410A	1set
Scraper	VTT-5	1pc
Package	Blow case	1pc



VTB-5B- II

Complete with	Description	Quantity
Flaring tool	VFT-808-I	1set
	VTC-28B	1pc
Tube cutter	VTC-19	1pc
	VTC-19	1pc
Manifold gauge	VMG-2-R410A	1set
Adapter	Optional: V01- V08	1set
Scraper	VTT-5	1pc
Package	Blow case	1pc



VTB-5B-III

Complete with	Description	Quantity
Flaring tool	VFT-808-I	1set
	VTC-28B	1pc
Tube cutter	VTC-19	1pc
	VTC-19	1pc
Manifold gauge	VMG-2-R410A	1set
Adapter	Optional: V01-V08	1set
Check valve	Optional: CV01-CV12	1set
Scraper	VTT-5	1pc
Package	Blow case	1pc

HVAC INSTRUMENT



**Modern Digital Multimeters
VDM-151**

- 30 different measuring ranges can be selected
- Overload protection for the full range
- The function to keep number of all shifts
- The max range of electric capacity is 200 μf
- Working temperature: 0°C~40°C
- Storage temperature: -10°C~50°C
- Weight: 300 g



**Digital Clamp Multimeters
VDM-202**

- Suitable for measuring AC/DC voltage, AC current, resistance, diode, °C/°F temperature and so on
- Automatic shut down for saving energy and low battery alarm
- 250V overload protection
- Max measurement voltage: 600V
- Max measurement AC current: 400A
- Temperature measurement range: -40°C~1000°C
- Weight: 360 g



**Infrared Thermometer
VDM-300**

- Emissivity: 0.95
- Temperature range: -18°C-280°C
- Max measuring accuracy: ±2°C or ±2%
- Ambient operation temperature: 23°C±2°C
- Resolution: 0.1
- Response time: 500 ms
- Weight: 185 g